

ett.com



# CRANE TYRE HANDLERS

SPECIALISED SUPPORT EQUIPMENT



ett.com



## ◀◀ ETT 4-TONNE CRANE TYRE HANDLER

ETT Tyre Handlers provide fast, safe and reliable operation. Our tyre handlers have an array of safety features and redundancy systems to ensure a safe working environment for the operator, as well as the mechanics working near the tyre being moved.

Strong and agile, our tyre handlers are designed to carry a wheel weight up to 4000 kilograms.

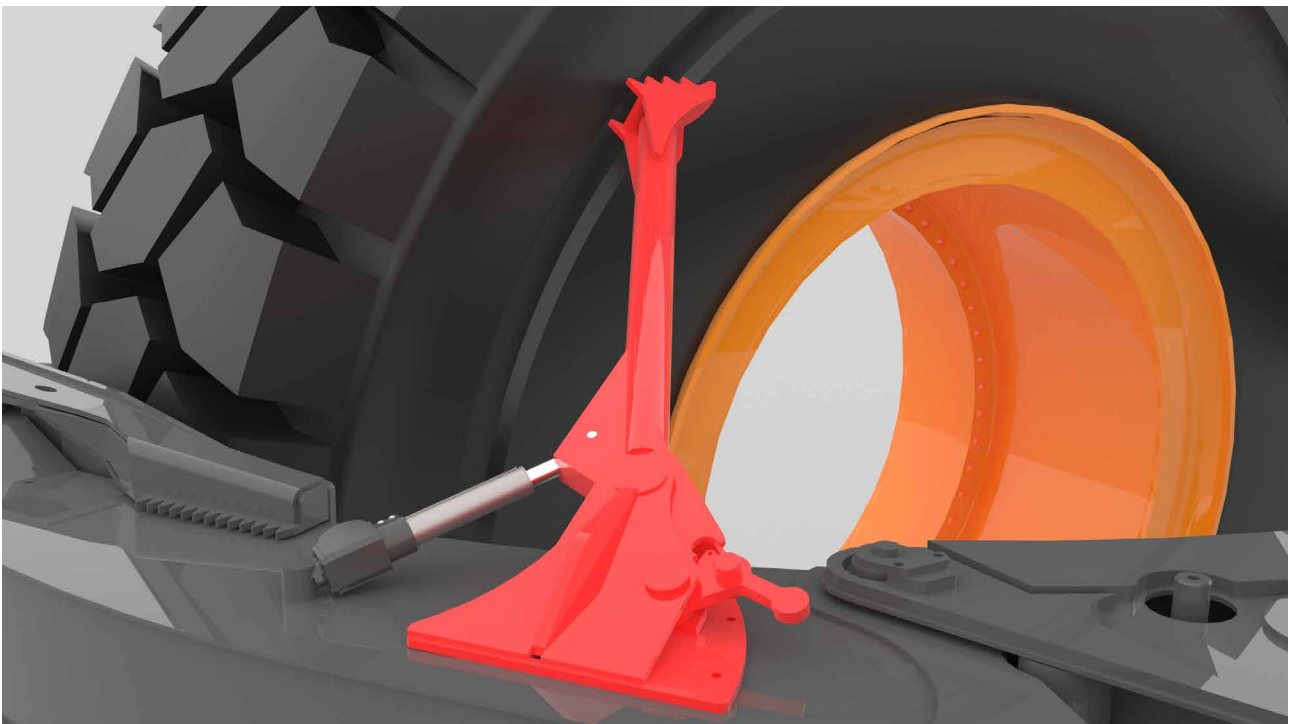

## ◀◀ OPTIONAL SAFETY ARMS

The optional safety arms will protect personnel in event of unintentional tyre release. These are deployed remotely to insure no personnel is put in harm's way. Once deployed, the operator can grab the tyre and a qualified technician or personnel can safely remove the wheel nuts.



## ◀◀ FAIL SAFE DESIGN

A series of automatic interlocks are intergrated into the control system, ensuring there is no accidental release of the tyre. This includes holding valves on grab cylinders and software interlocks.

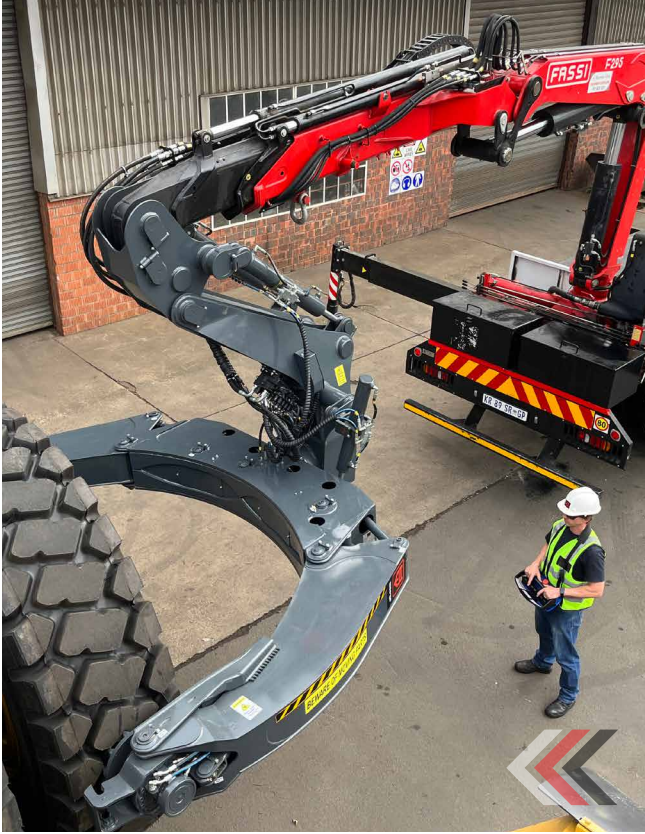

## ◀◀ REMOTE CONTROLLED

The remote controller is easy to use and intuitive to operate, and is designed with software safety interlocks. Years of exhaustive and demanding testing have shown that the remote control system can cope with the roughest of environments. The system is also protected against electromagnetic and radio frequency radiation. The remote controller is also fitted with a safety emergency stop function.

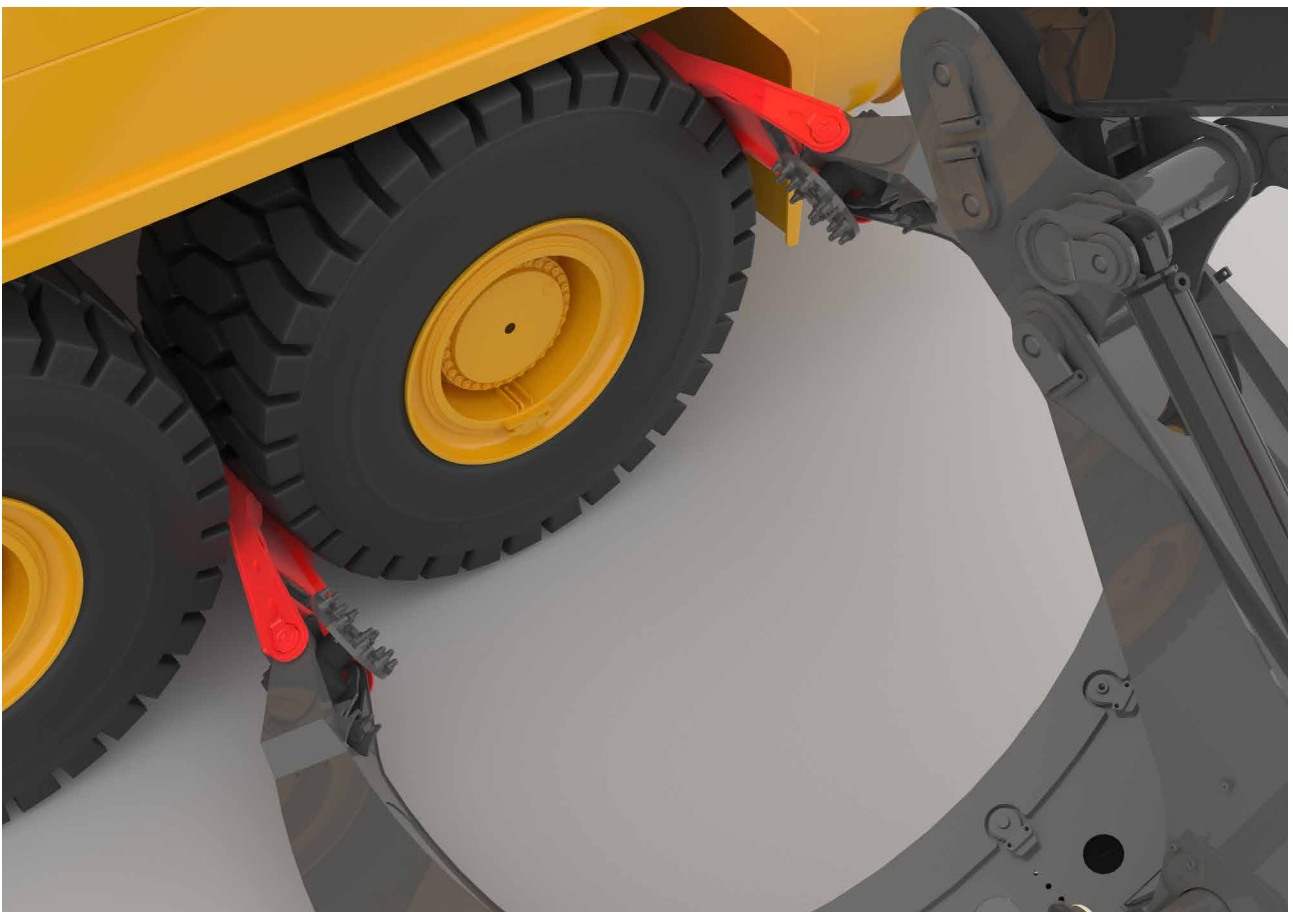

## ◀◀ LOW PROFILE GRABS

The Low Profile Grabs on the ETT Tyre Handlers allow working in confined wheel wells such as articulated trucks.

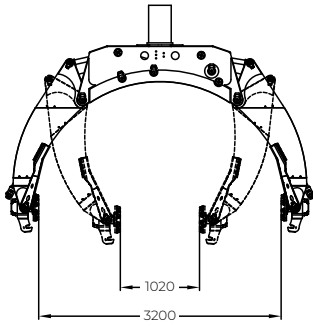

GRAB RANGE

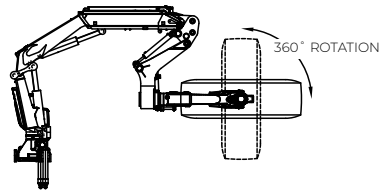

TYRE TILT / ROTATION

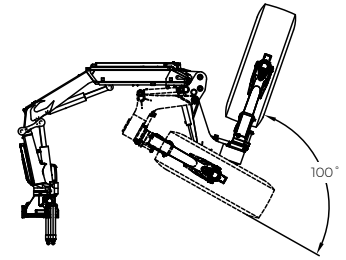

GRAB TILT

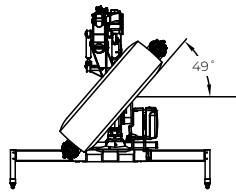
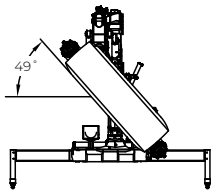

OSCILLATION / SLEW

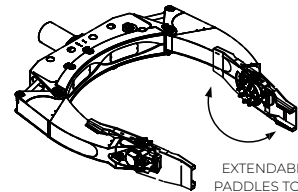

EXTENDABLE GRIP PADDLES TO ACCESS CONFINED TYRES

PADDLE EXTENSION

## MOVEMENT

Tyre pitch and roll can be precisely adjusted using the intuitive remote control system, allowing the operator to easily align the tyre for installation. Tyre pitch is manipulated through powerful and accurate hydraulic motors coupled to the rotator pads. Tyre roll is achieved through rotating the entire grab assembly with a hydraulic cylinder.



## CLAMPING

Optimised clamping force for safe and effective tyre clamping. Grip studs on tyre clamping surfaces ensure effective tyre clamping with zero tyre damage.

## DESIGN

The claw arm kinematics are designed with a mechanical parallel linkage system which ensures that the clamping force is always symmetrical and accurate. The tyre handler assembly is constructed from high tensile steel and is fully blasted and painted, ensuring high durability and long-lasting quality in the most extreme mining environments.

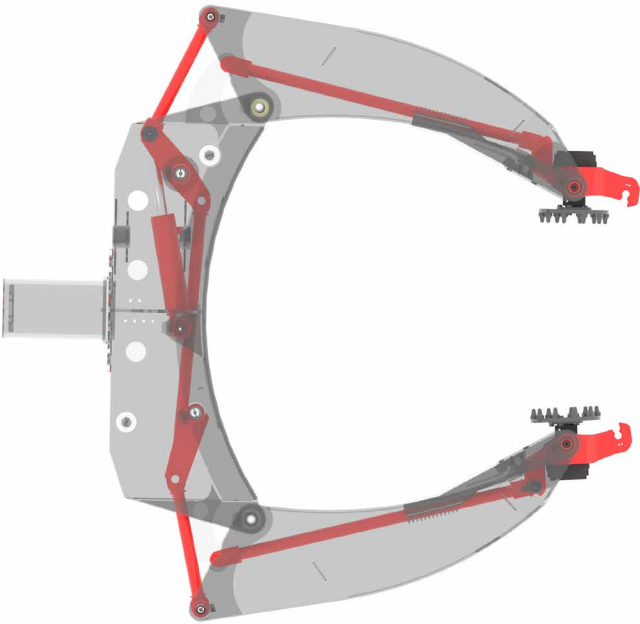

## CAPABILITY

The crane truck tyre handler is ideally suited for cases where the tyre needs to be transported by road over longer distances. Tyres can be loaded on the truck flat deck, and installed on site. The crane truck tyre handler is designed to be road legal with an overall height of 4.2 m when the crane is resting in the transport configuration.





## «« DISTINCT PERFORMANCE ADVANTAGE

Making light work of tyre replacement in confined spaces, ETT's Tyre Handler range gets the job done safely and efficiently. Up to 4000kg, and from diameters of 1.1- to 3.2-metre, there is a solution for your service needs.

# 25+

YEARS' SERVICE  
IN THE HARSHTEST  
ENVIRONMENTS



**ISO CERTIFIED**  
ISO 14001 : 2015



**ON-SITE ASSEMBLY**



**SERVICE**

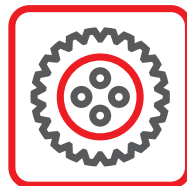

**SPARES**



**ACCESSORIES**

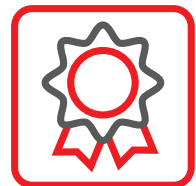

**QUALITY**

ETT maintains a complete inventory of repair and maintenance parts for all of our products to include accessory kits and service parts packages. Our professionally trained team of engineers and support staff are focused on ensuring your asset's optimal performance and ultimately your satisfaction with ETT products.

Under our policy of continuous improvement, we reserve the right to change technical data and design without prior notice. Photographs featured in this brochure may include optional equipment.

## «« CONTACT US

[ett.com](http://ett.com)



ett.com